

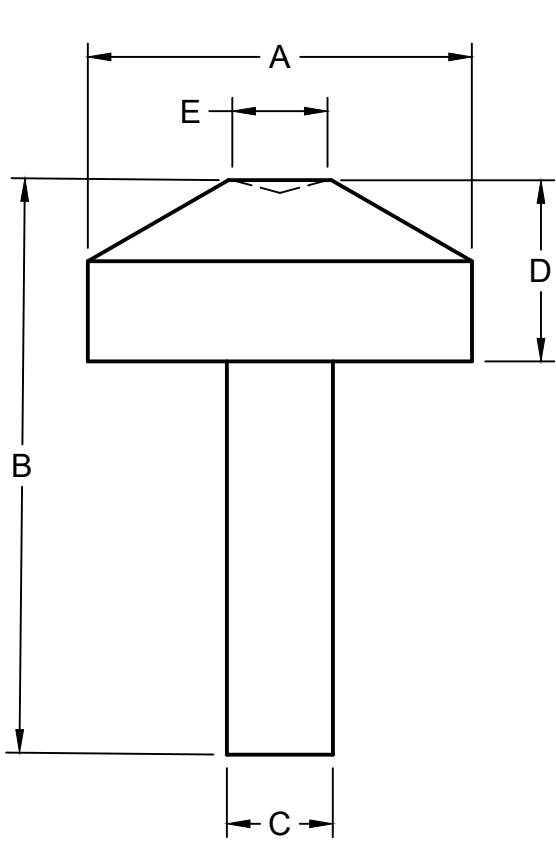

Stock Electrodes

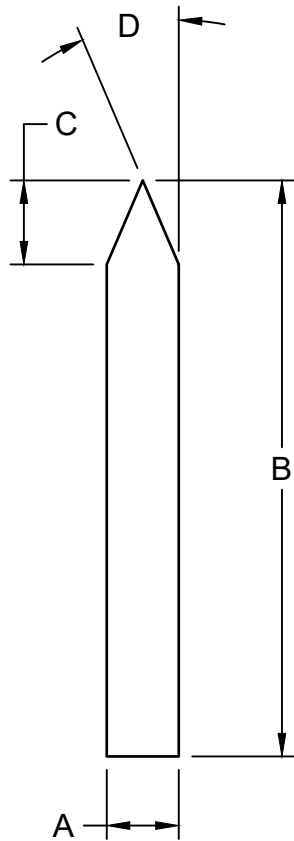

Pellet Holder



Pointed



Rounded

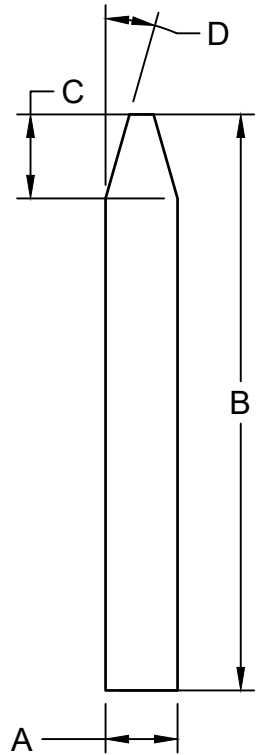

Flat Tip

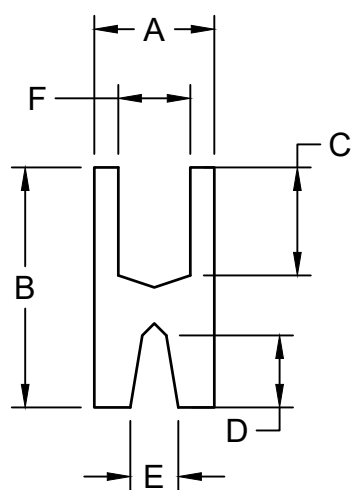

Anode Cup

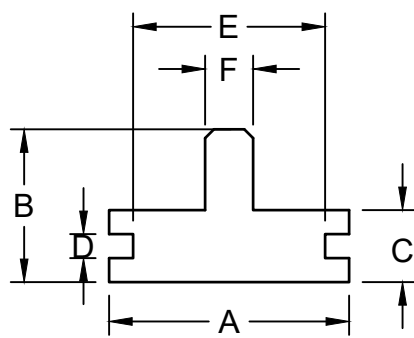

Pedestal

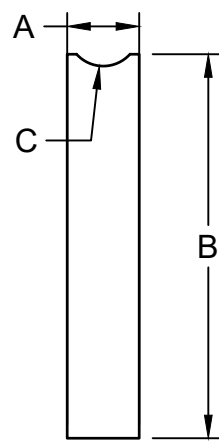

Radius Crater

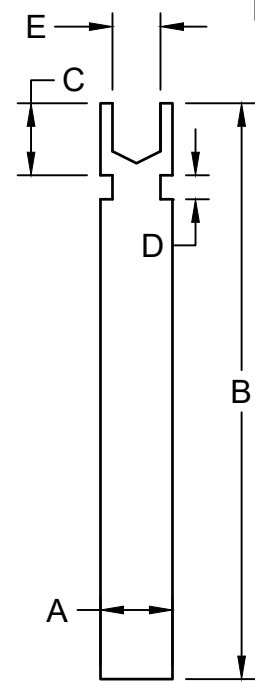

Necked Crater

Type	Part Number	Dim A	Dim B	Dim C	Dim D	Dim E	Dim F	High Purity
Pellet Holder	2023	1.000	1.496	.276	.472	.248		Yes
Pointed	C-1	.120*	1.500	.312	8°			Yes
Rounded	C-120	.120*	1.500	1/32R	15°			Yes
Rounded	C-180	.180*	1.500	1/16R	15°			Yes
Flat Tip	S-1	.120*	1.500	.125	8°			Yes
Anode Cup	S-2	.242*	.620	.280	.160	.125	.160	Yes
Anode Cup	S-3	.242*	.620	.280	.160	.125	.187	Yes
Pedestal	1506	.497	.439	.125	.065	.375	.122/.124	Yes
Radius Crater	Sp-9012	.242*	1.000	.125R				Yes

All Dimensions are in Inches Dimensions Marked (*) Are Ground within .001"